

FIG. 1

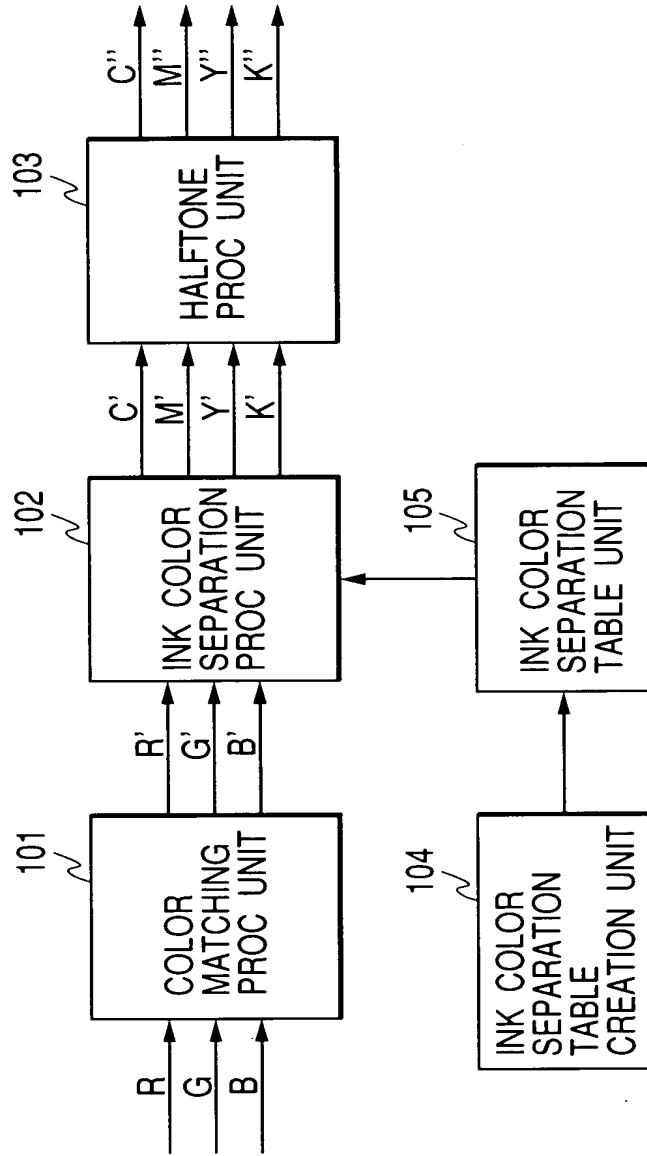

FIG. 2A

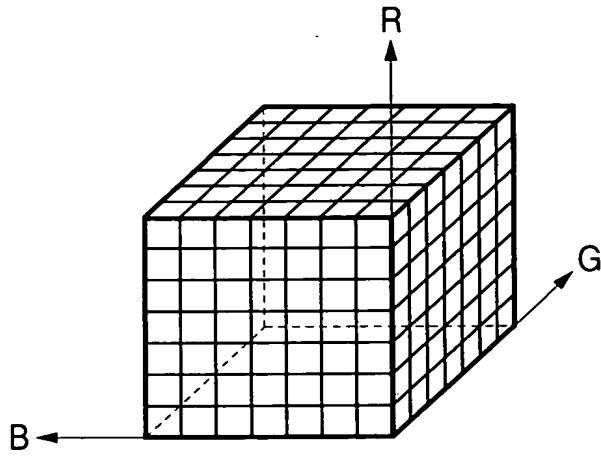

FIG. 2B

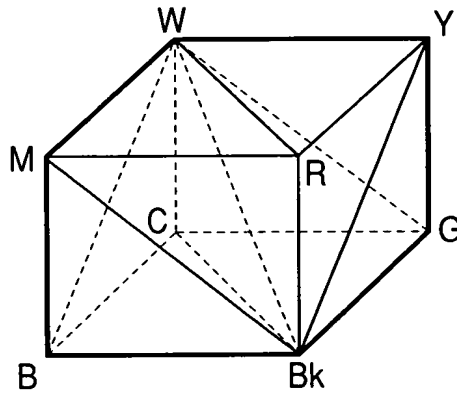
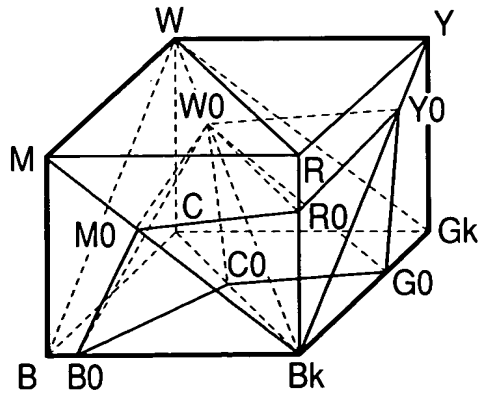

FIG. 2C



TOP OF 6720060

FIG. 3

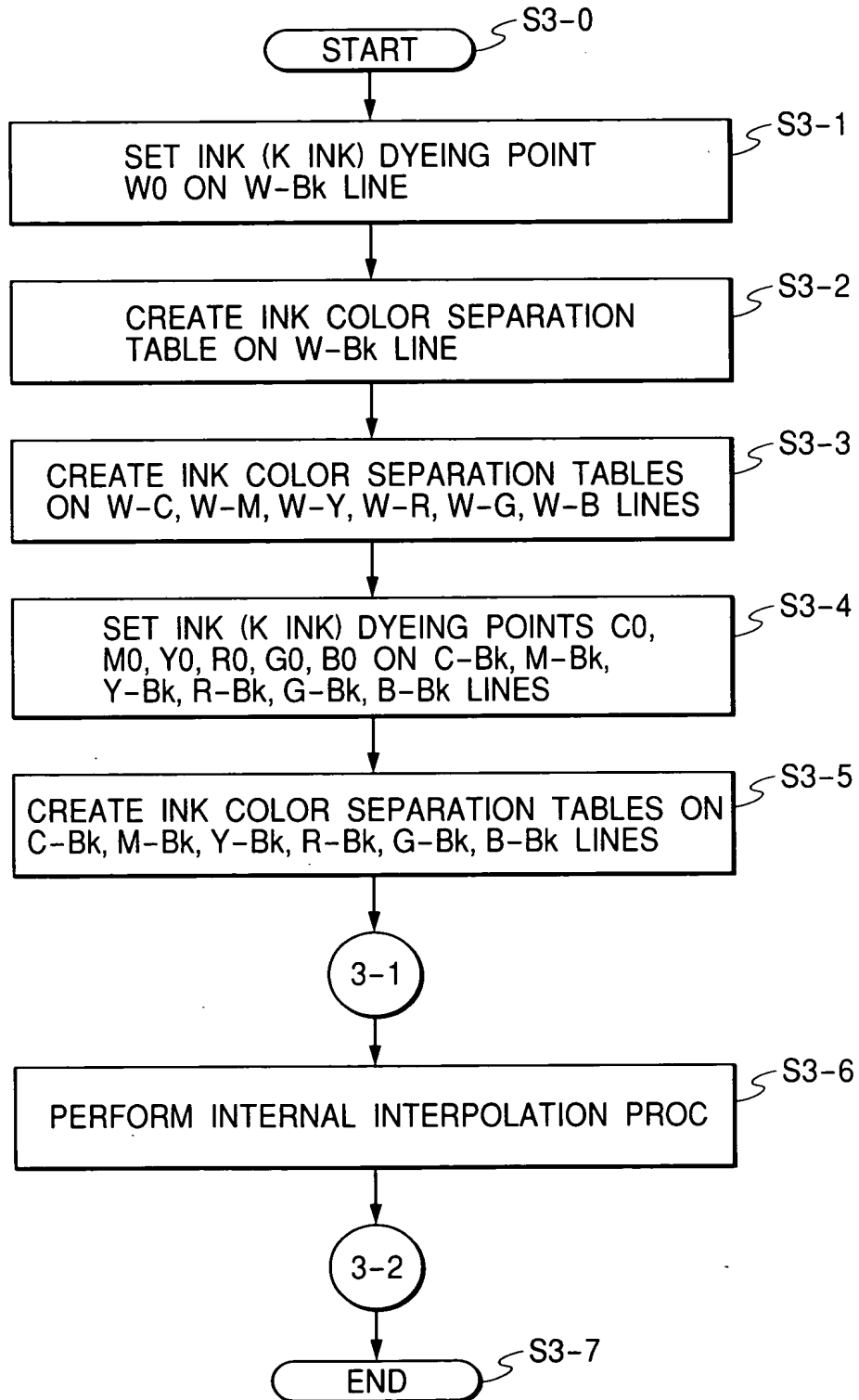
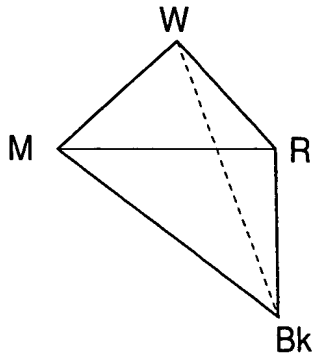
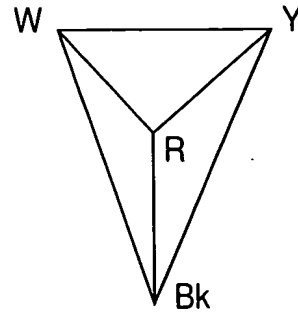

FIG. 3

**FIG. 4A**



**FIG. 4D**



**FIG. 4B**

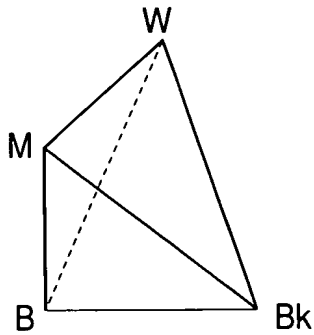

**FIG. 4E**

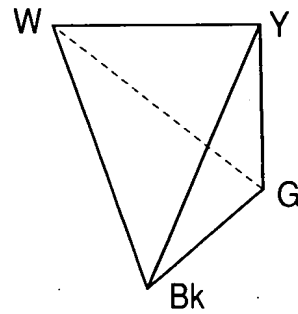

**FIG. 4C**

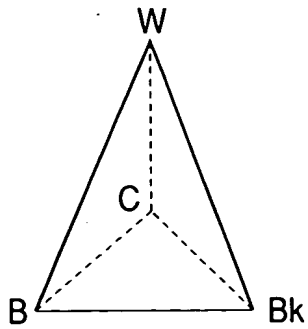

**FIG. 4F**

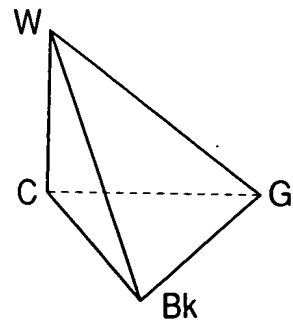

FILED AT 2006

FIG. 5

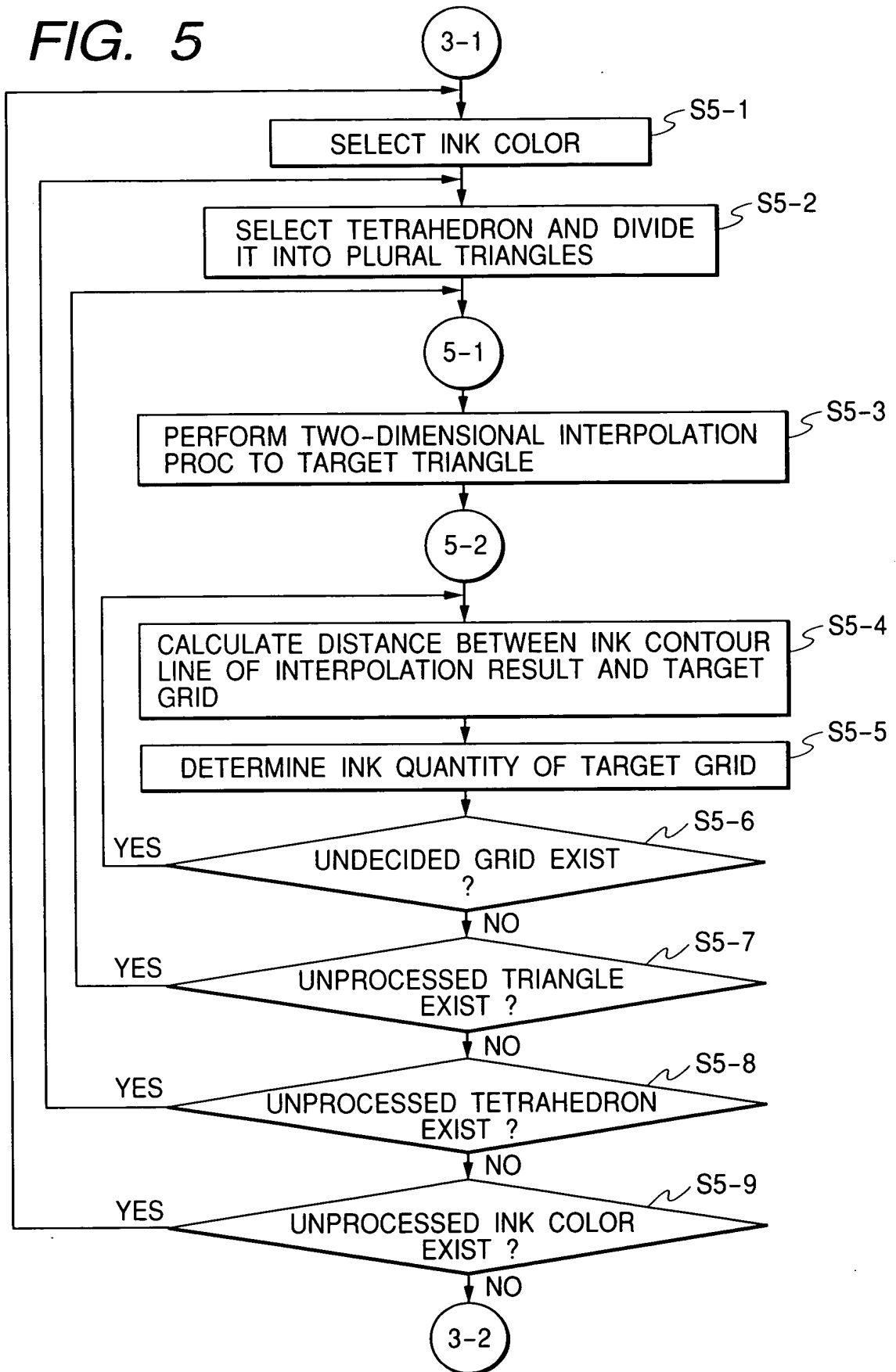

FIG. 5 OF 200600

FIG. 6

FOE420 BT 20666

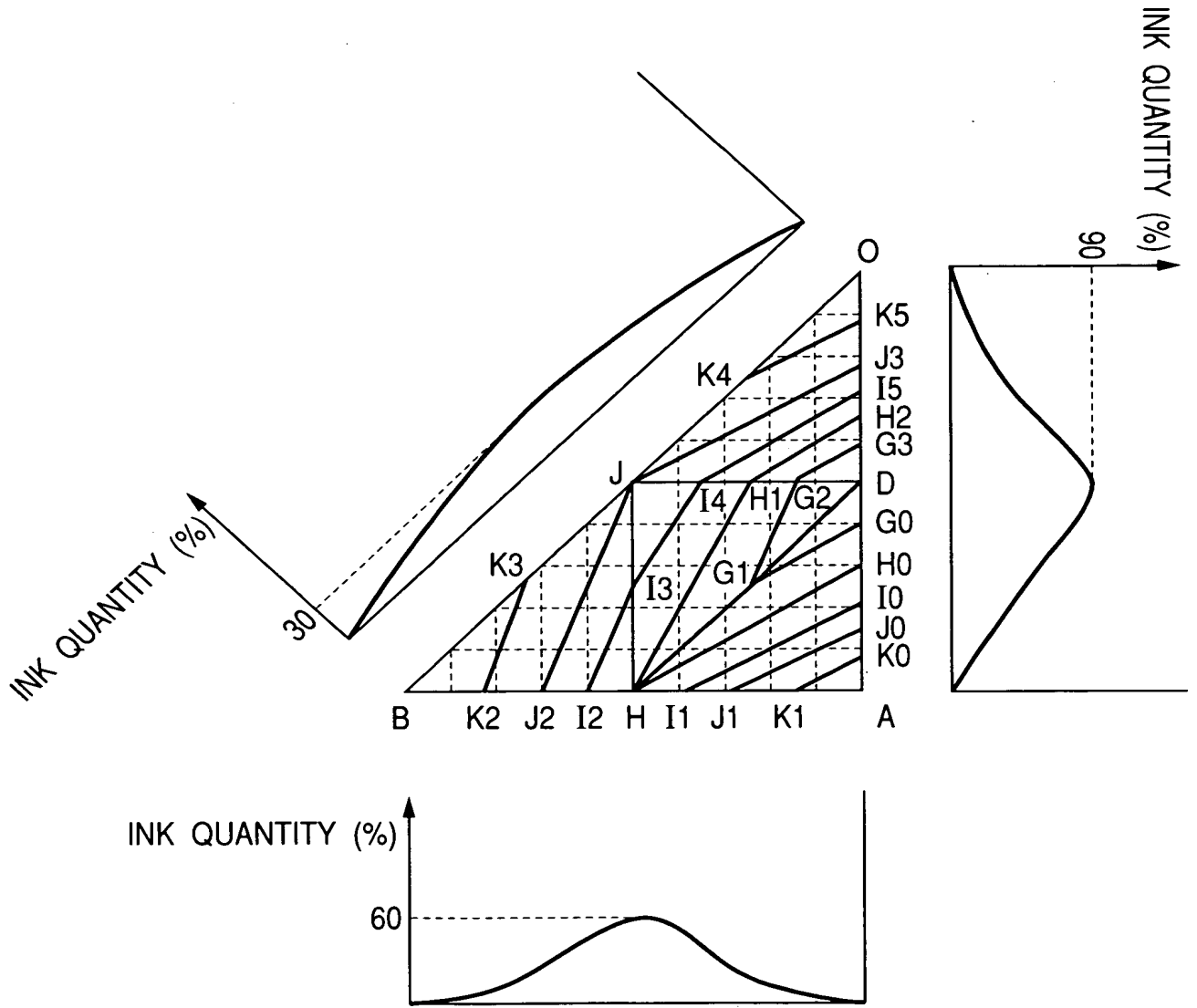

FIG. 7

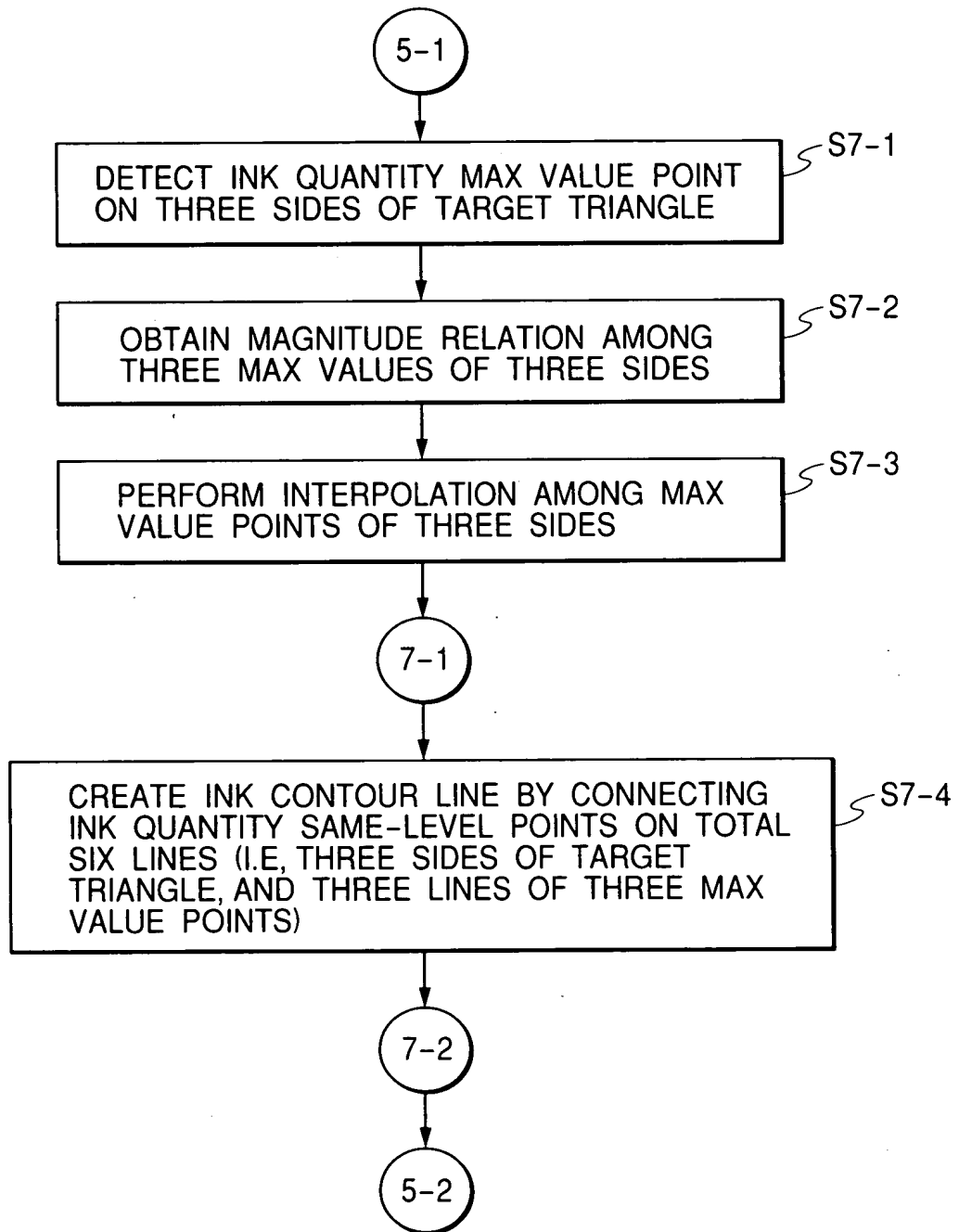

FIG. 7

FIG. 8

7-1

S8-1  
 SET MAX POINT AS POINT D, ITS MAGNITUDE AS d,  
 INTERMEDIATE POINT AS POINT H, ITS MAGNITUDE AS h,  
 MIN POINT AS POINT J, AND ITS MAGNITUDE AS j,  
 IN THREE MAX VALUE POINTS

S8-2  
 SET VERTEX OF SIDE INCLUDING POINT D  
 AND SIDE INCLUDING POINT H AS A,  
 VERTEX OF SIDE INCLUDING POINT H  
 AND SIDE INCLUDING POINT J AS B,  
 AND VERTEX OF SIDE INCLUDING POINT J  
 AND SIDE INCLUDING POINT D AS O

S8-3  
 SET INTERVAL  $s$  OF CREATED CONTOUR LINES,  
 AND INITIAL VALUE  $i=d-s$

S8-4  
 YES NO  
 $d > i \geq h ?$

S8-6  
 CONNECT POINTS OF VALUE  $i$   
 BETWEEN DA AND DH,  
 BETWEEN DH AND DJ,  
 AND BETWEEN DJ AND DO

S8-5  
 YES NO  
 $h > i \geq j ?$

S8-8  
 CONNECT POINTS OF VALUE  $i$   
 BETWEEN DA AND AH,  
 BETWEEN HB AND BJ,  
 AND BETWEEN JO AND DO

S8-7  
 CONNECT POINTS OF VALUE  $i$   
 BETWEEN DA AND AH,  
 BETWEEN HB AND HJ,  
 BETWEEN HJ AND DJ,  
 AND BETWEEN DJ AND DO

S8-9  
 YES  
 $i = 0 ?$

7-2

S8-10  
 $i = i - s$

S8-11  
 YES NO  
 $i > 0 ?$

S8-12  
 $i = 0$

FIG. 8 OF 200000



FIG. 9

FIG. 9A

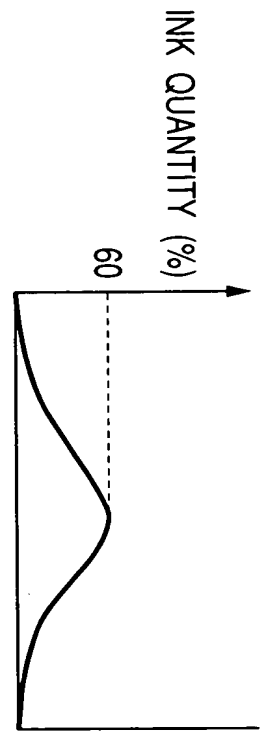
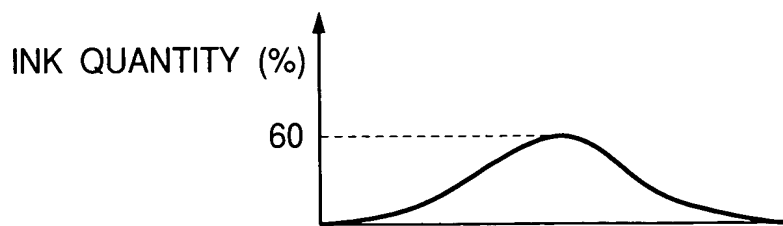
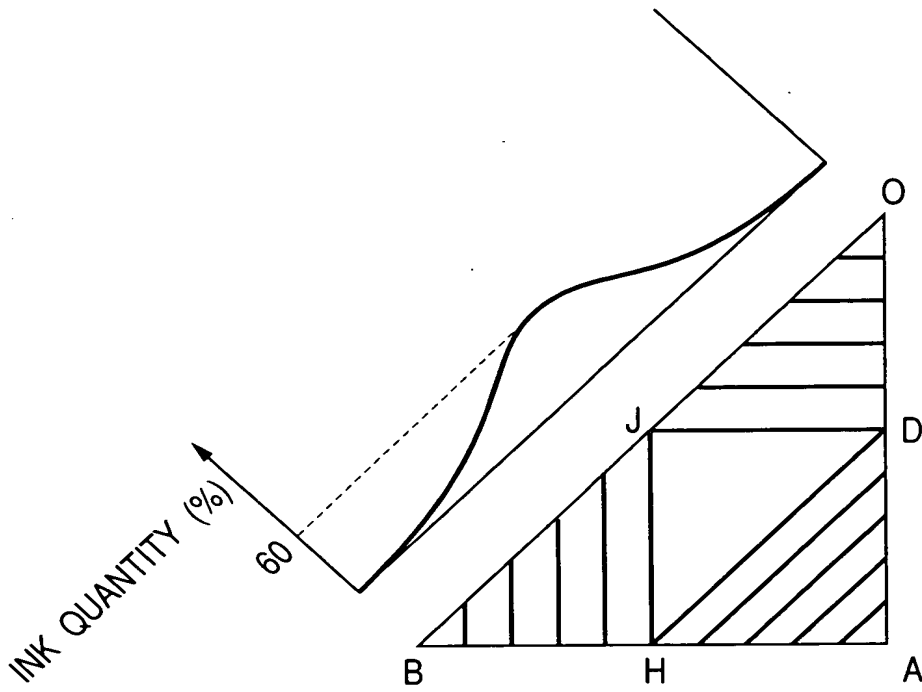

FIG. 10

FIG. 10 - 6720000

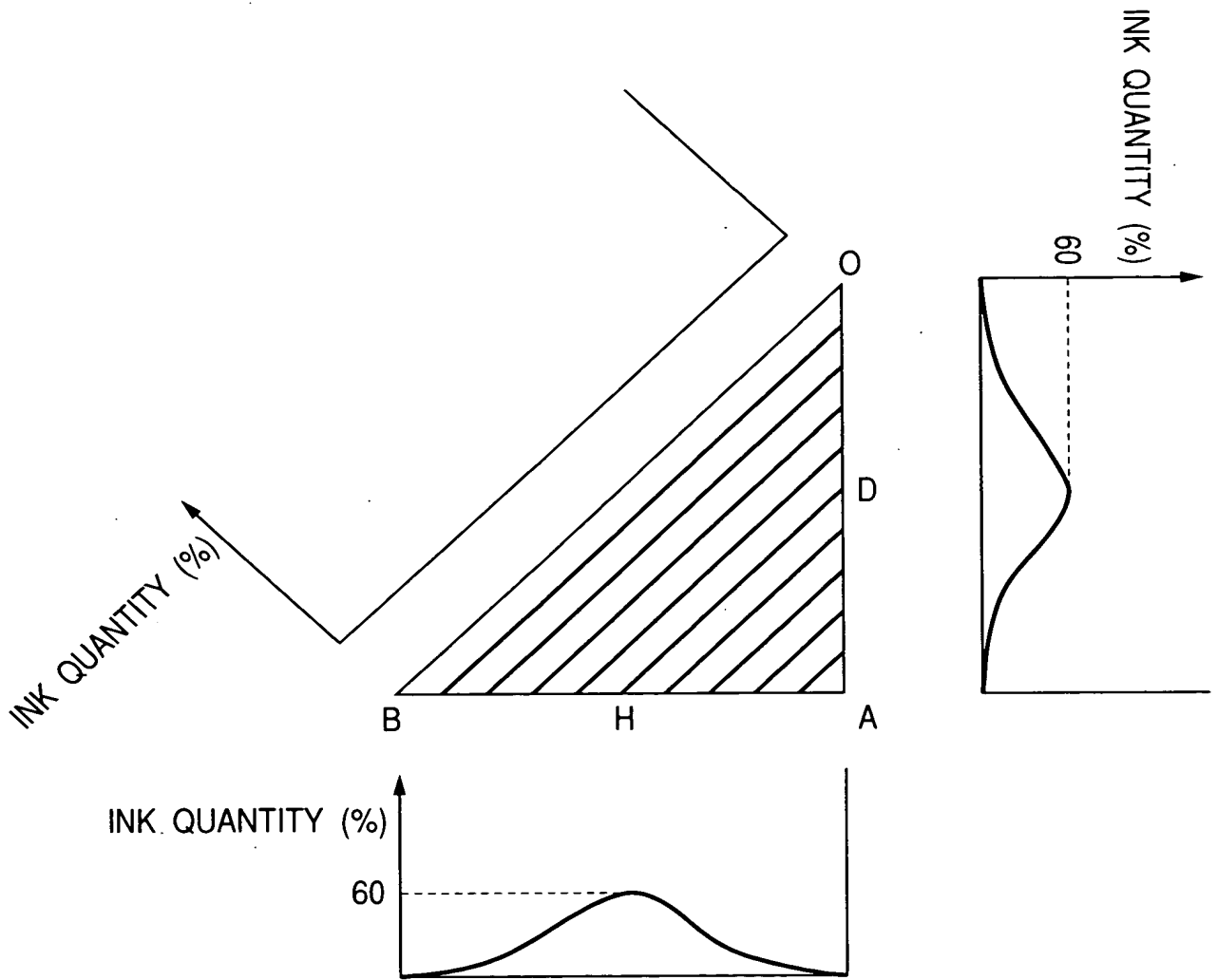

FIG. 11

09923-0320

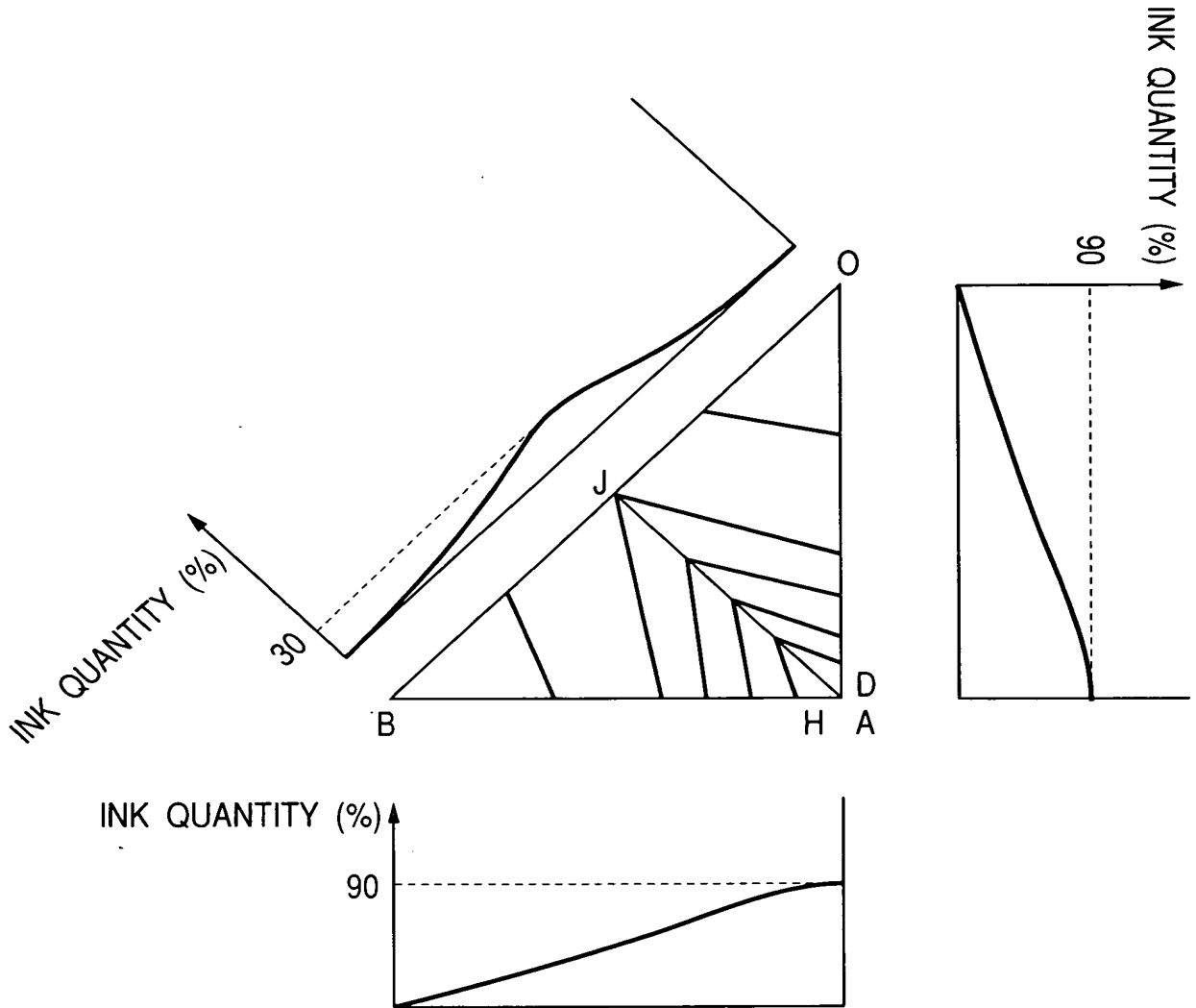
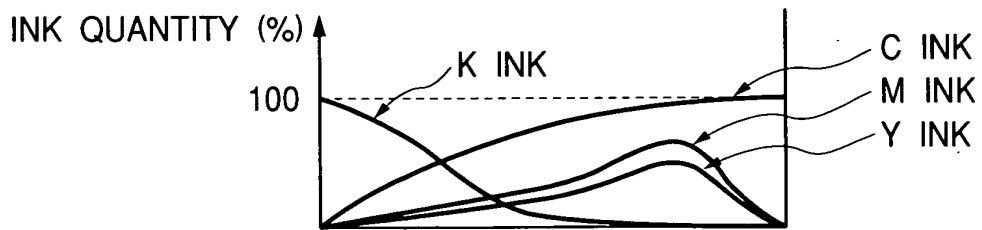
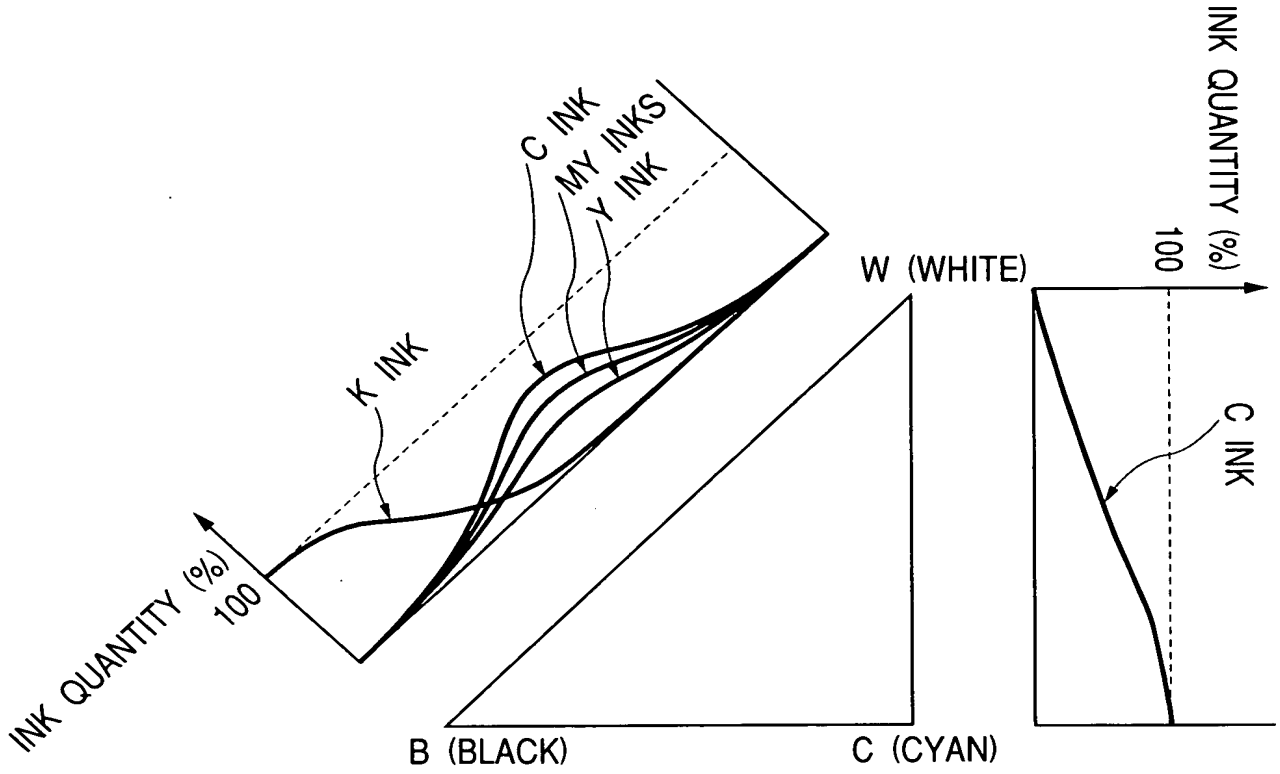
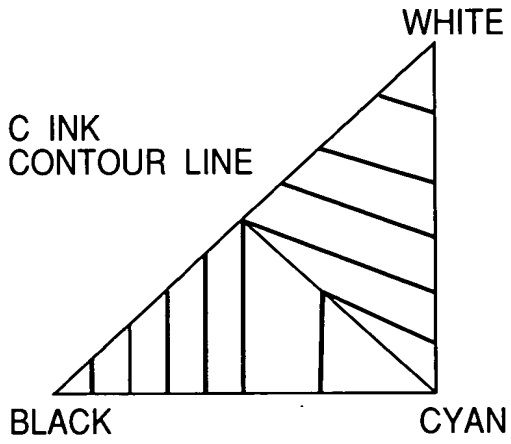

FIG. 12



FILE NO. 67-2060

**FIG. 13A**



**FIG. 13B**

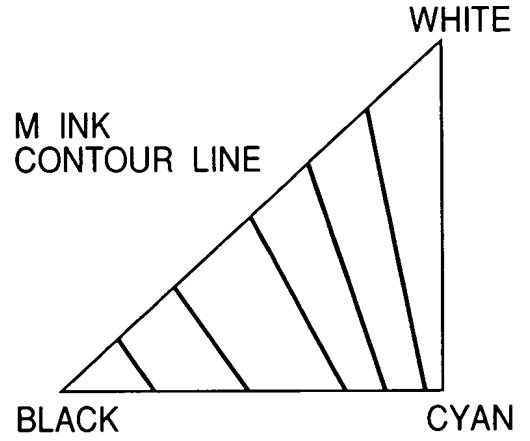

**FIG. 13C**

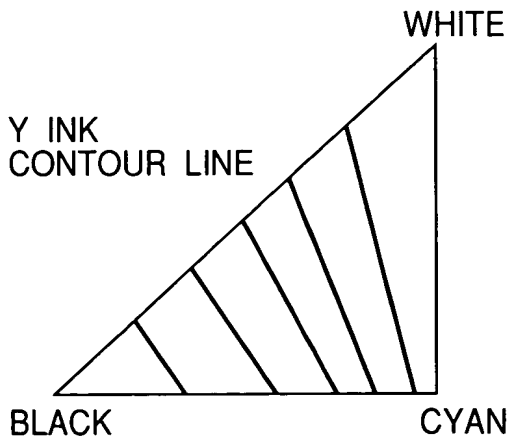

**FIG. 13D**

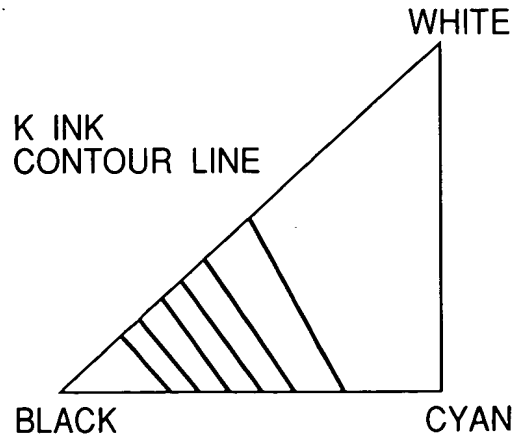

FIG. 13A

FIG. 14

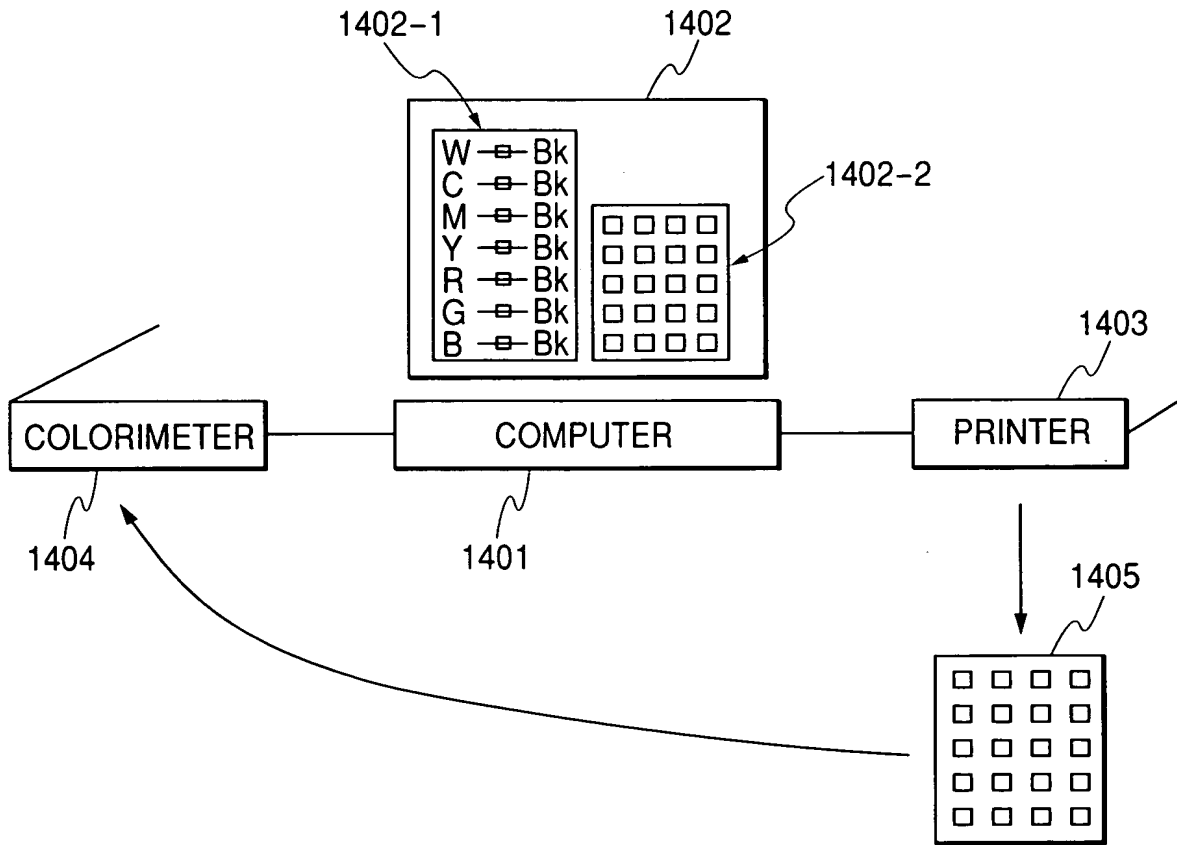

FIG. 14

FIG. 15

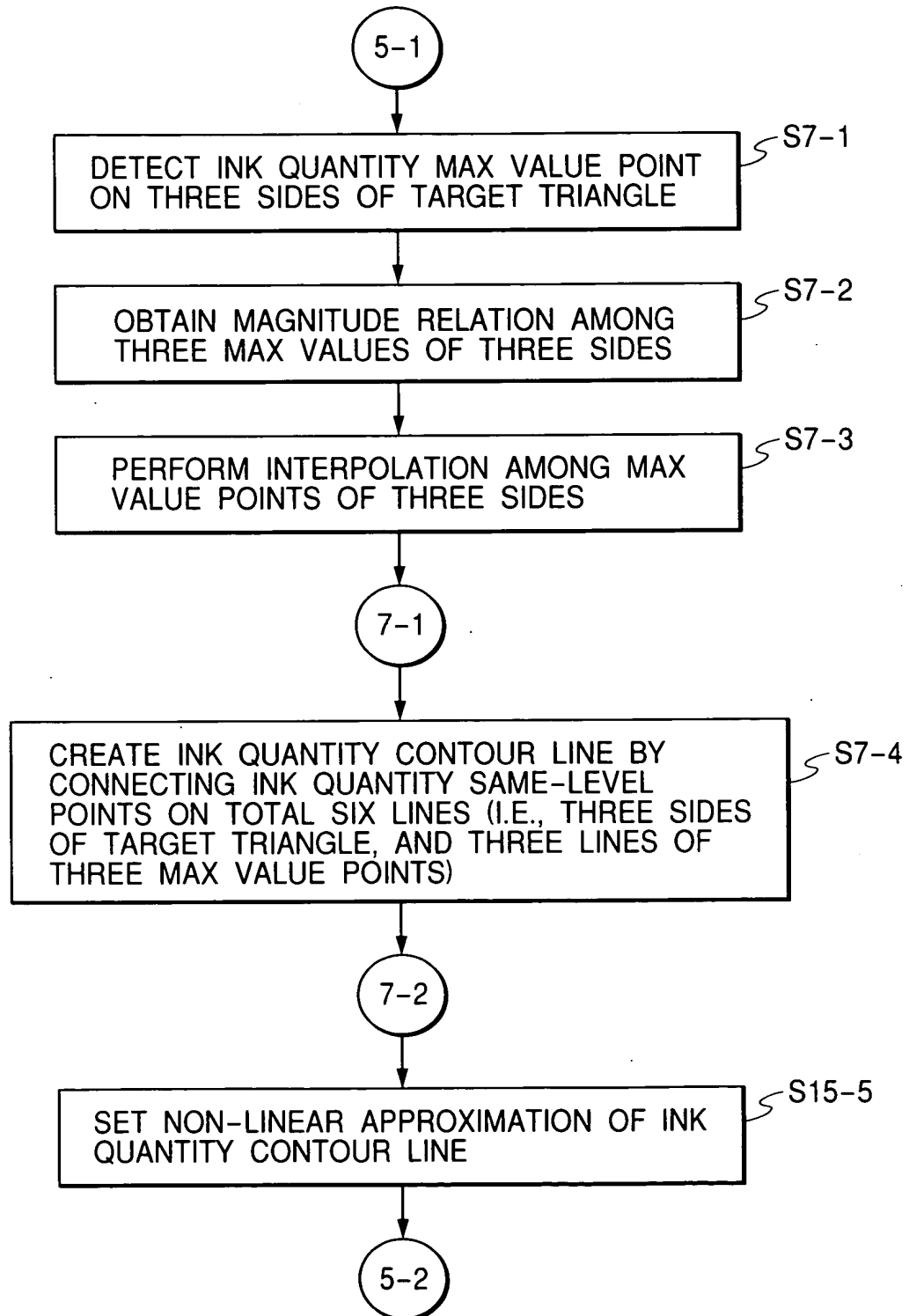

FIG. 15

FIG. 16

099949-01

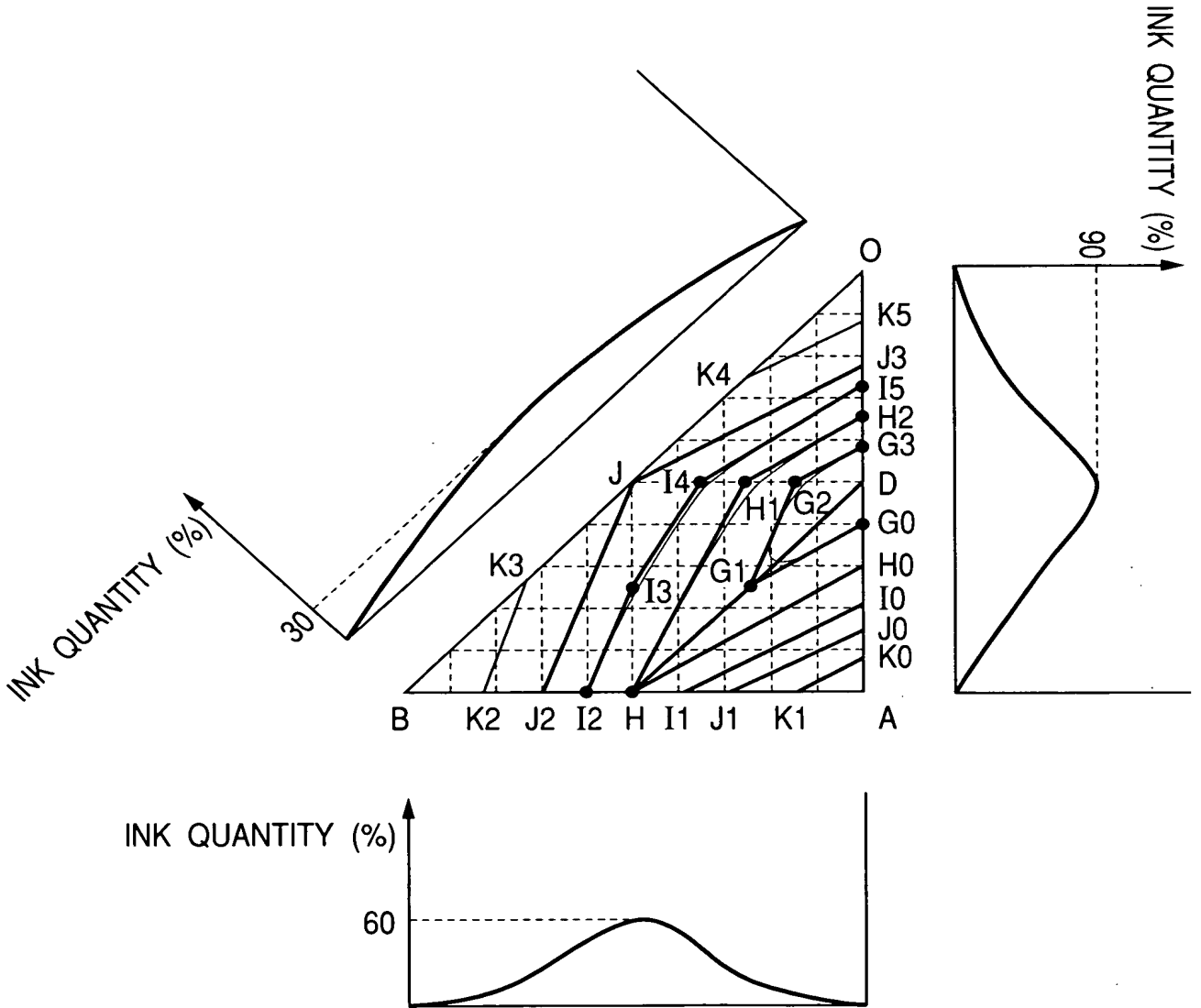
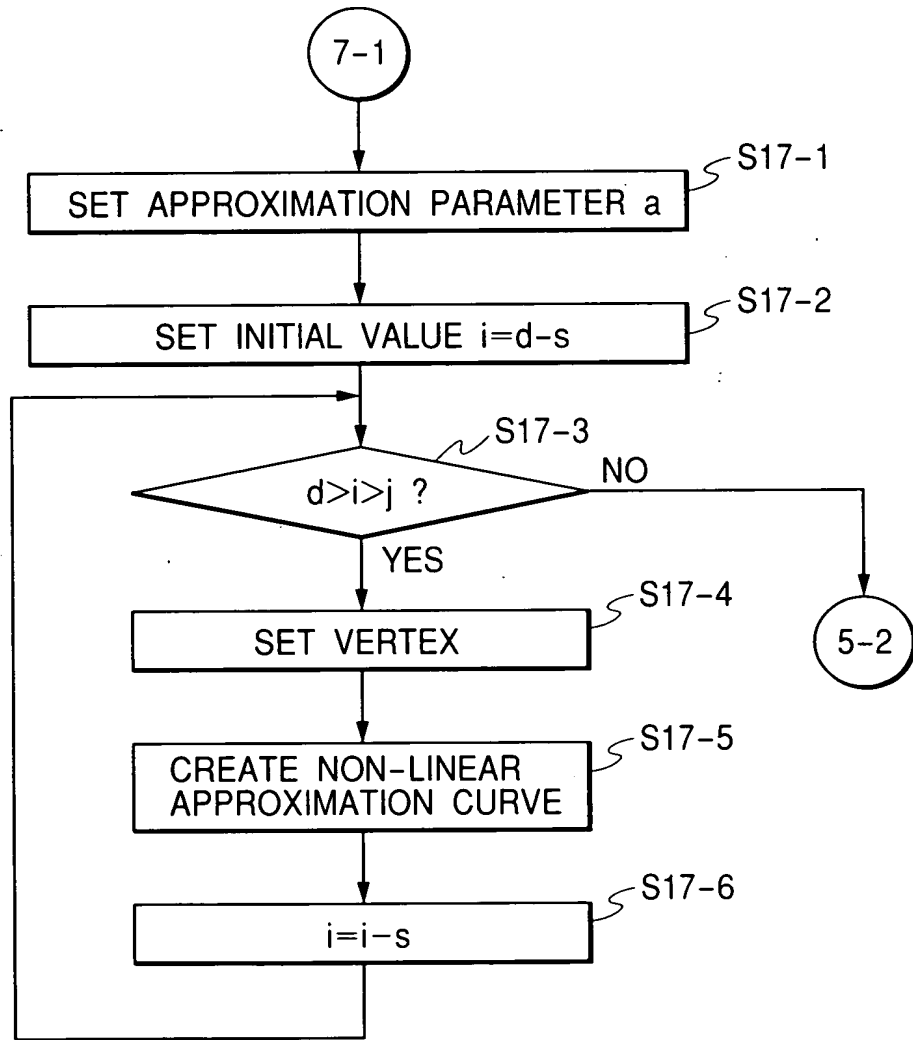



FIG. 17



TOP SECRET

FIG. 18

FIG. 18

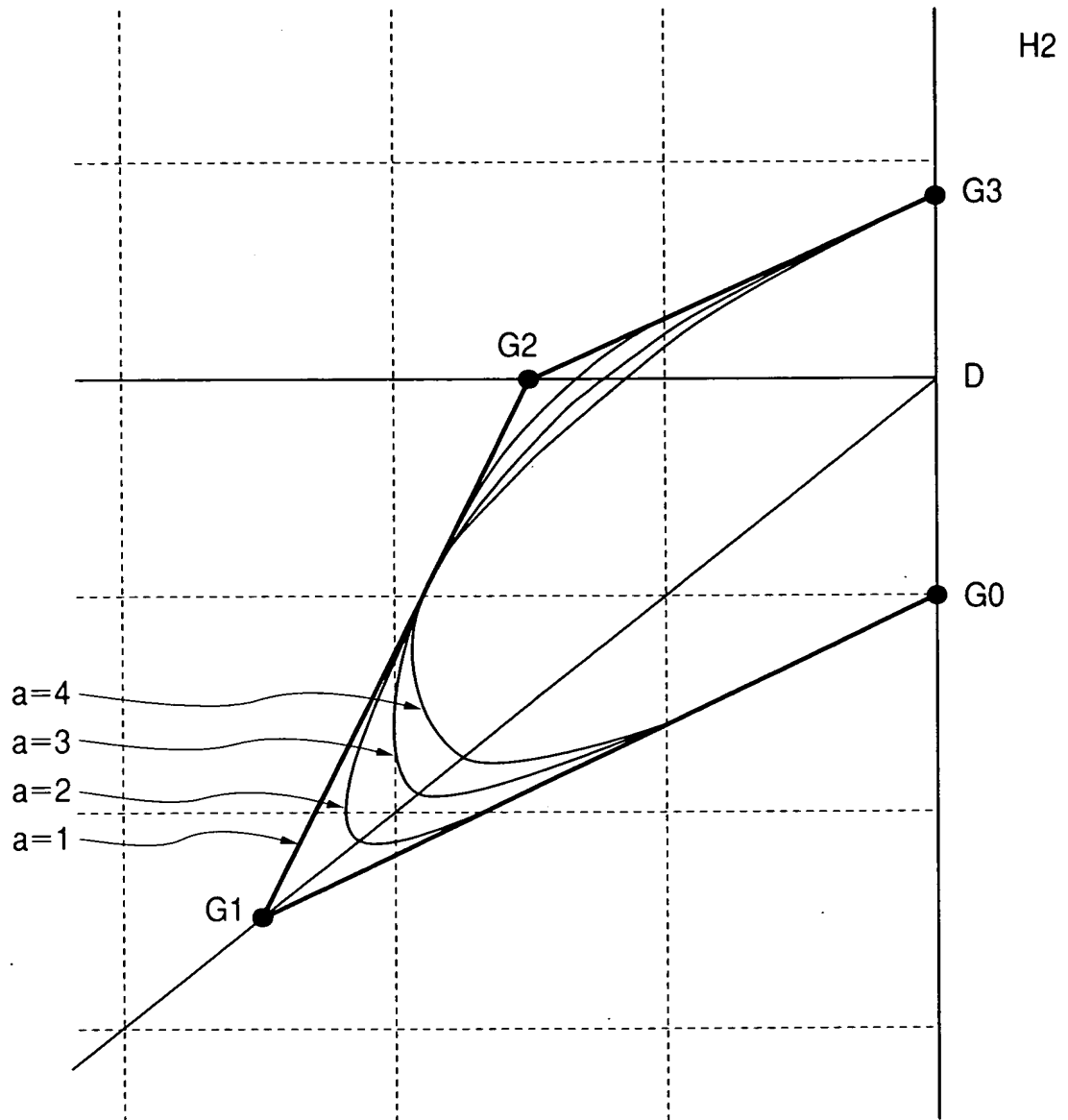
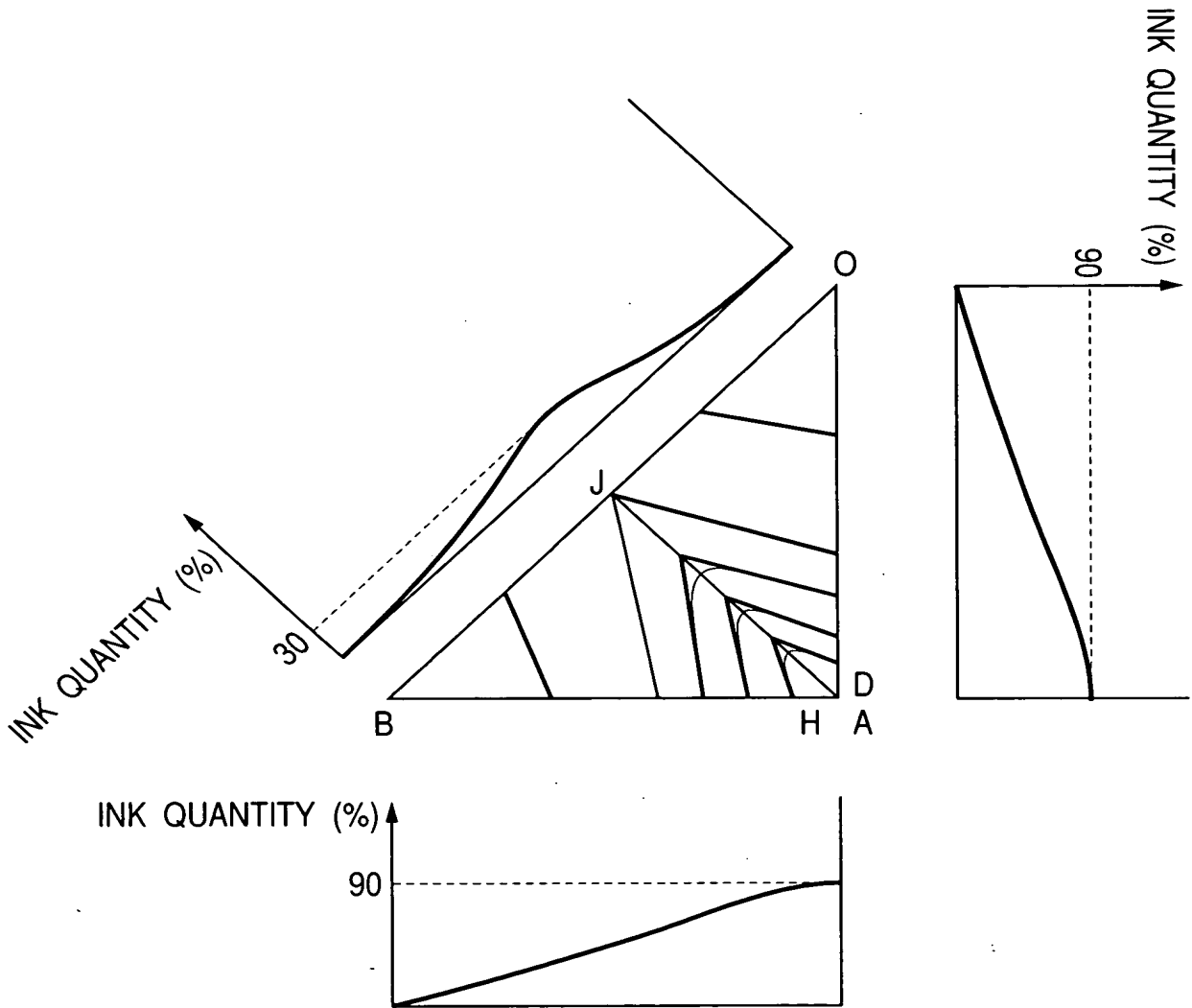
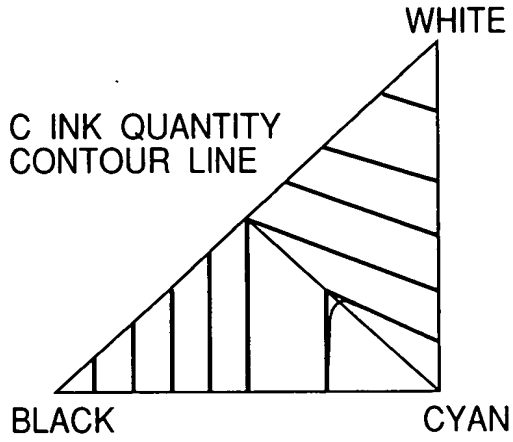

FIG. 19

TOP OF 6742060



**FIG. 20A**



**FIG. 20B**

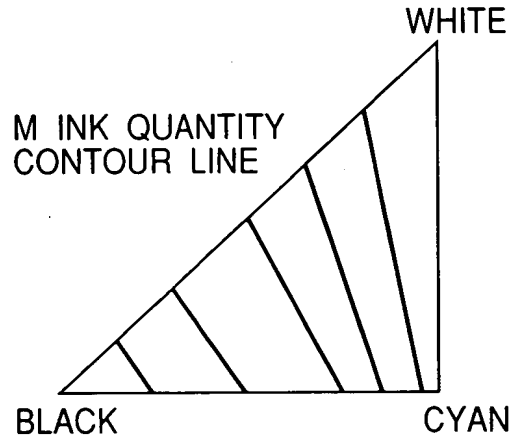

**FIG. 20C**

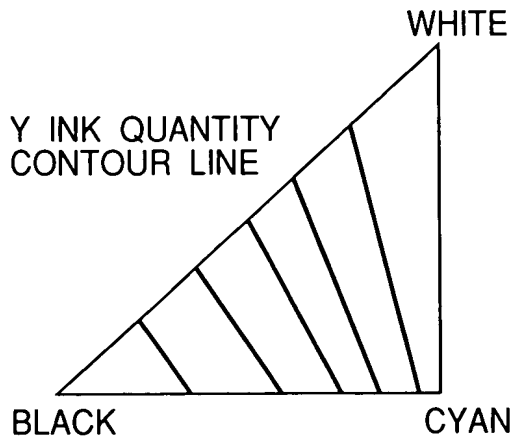

**FIG. 20D**

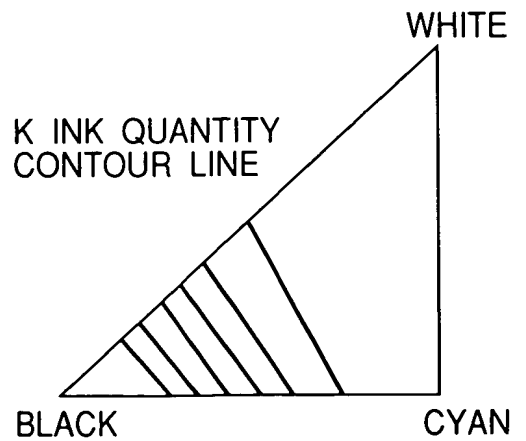

FIG. 20A-20D

FIG. 21

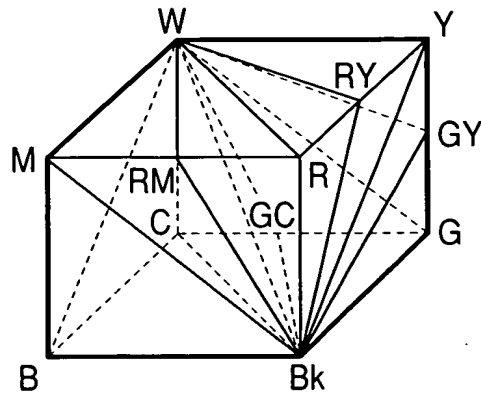

FIG. 22

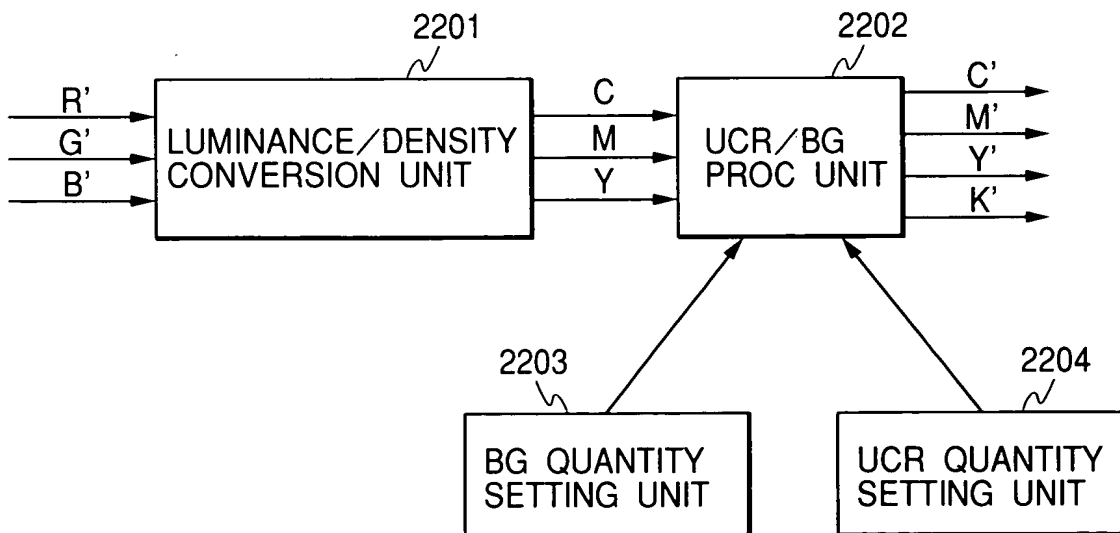

FIG. 20 of 2000